

# Slat-Wall Workshop

## Materials & Hardware List

### SLAT WALL (3 sections shown)

A Back Panels (3)	48 x 64 - 3/4 Ply.
B Slats (21)	5 7/8 x 48 - 3/4 Ply.
C Top/Bottom Fillers (6)	2 15/16 x 48 - 3/4 Ply.

### CORD HOOKS (2 shown)

D Backs (2)	7 x 7 - 3/4 Ply.
E Faces (2)	3 1/2 x 5 7/8 - 3/4 Ply.
F Brackets (4)	3 x 3 1/2 - 3/4 Ply.
G Cleats (2)	2 x 7 - 3/4 Ply.

### PEGBOARD

H Panel (1)	23 1/2 x 43 1/2 - 1/4 Pegboard
I Rails (2)	1 3/4 x 40 - 3/4 Ply.
J Stiles (2)	1 3/4 x 23 1/2 - 3/4 Ply.
K Cleat (1)	2 x 43 1/2 - 3/4 Ply.

### WORKSTATION

L Side Supports (2)	15 x 14 - 3/4 Ply.
M Drawer Divider (1)	15 x 21 - 3/4 Ply.
N Filler Block (1)	3 1/4 x 20 1/2 - 1 1/2 Ply.
O Top Layers (2)	16 x 24 - 3/4 Ply.
P Cleat (1)	2 x 24 - 3/4 Ply.
Q Drawer Front/Back (2)	1/2 x 23 3/4 - 19
R Drawer Sides (2)	1/2 x 23 3/4 - 12
S Drawer Bottom (1)	11 1/2 x 19 - 1/4 Hdbd.
T Drawer False Front (1)	3 1/8 x 20 3/8 - 3/4 Ply.

### CABINET

U Case Sides (2)	7 1/4 x 28 - 3/4 Ply.
V Case Top/Bottom (2)	7 1/4 x 20 - 3/4 Ply.

W Case Back (1)

X Doors (2)	10 7/16 x 28 - 3/4 Ply.
Y Shelf (1)	6 1/2 x 19 3/8 - 3/4 Ply.
Z Cleat (1)	2 x 21 - 3/4 Ply.

### BINS (6 shown)

AA Ends (12)	5 x 7 3/4 - 3/4 Ply.
BB Fronts (6)	5 9/16 x 17 - 3/4 Ply.
CC Backs (6)	5 x 17 - 3/4 Ply.
DD Bottoms (6)	3 3/4 x 17 - 3/4 Ply.
EE Cleats (6)	2 x 18 - 3/4 Ply.

### TOOL TOTE RACKS (2 shown)

FF Sides (4)	5 x 24 - 3/4 Ply.
GG Rack Shelves (6)	9 x 20 - 3/4 Ply.
HH Shelf Lips (6)	1/2 x 1 1/4 - 20
II Cleats (2)	2 x 21 - 3/4 Ply.

### TOOL TOTES (6 shown)

JJ Ends (12)	1/2 x 5 3/4 - 8
KK Fronts/Backs (12)	1/2 x 2 1/2 - 18 1/2
LL Bottoms (6)	8 x 18 - 1/4 Hdbd.
MM Handles (6)	3/4"-dia. x 18" EMT Conduit

### SHELVES

#### (3 small, 2 medium, and 1 large shown)

NN Sm. Shelf Tops (3)	6 x 24 - 3/4 Ply.
OO Sm. Shelf Backs (3)	3 x 20 1/2 - 3/4 Ply.
PP Sm. Shelf Supports (6)	5 x 4 1/2 - 3/4 Ply.
QQ Med. Shelf Tops (2)	9 x 24 - 3/4 Ply.
RR Med. Shelf Backs (2)	4 1/2 x 20 1/2 - 3/4 Ply.

SS Med. Shelf Supports (4)	7 1/2 x 6 3/4 - 3/4 Ply.
TT Lg. Shelf Top (1)	12 x 24 - 3/4 Ply.
UU Lg. Shelf Back (1)	6 x 20 1/2 - 3/4 Ply.
VV Lg. Shelf Supports (2)	10 x 9 - 3/4 Ply.
WW Cleats (6)	2 x 22 - 3/4 Ply.

### SPRAY CAN RACK

XX Sides (2)	5 x 34 1/2 - 3/4 Ply.
YY Backs (2)	3 1/2 x 16 1/2 - 3/4 Ply.
ZZ Rails (9)	1/2"-dia. x 17" EMT Conduit
AAA Cleat (1)	2 x 18 - 3/4 Ply.

- (1 pr.) 12" Full-Extension Drawer Slides
- (3) Door Pulls
- (2 pr.) 2 1/2" No-Mortise Hinges w/Screws
- (4) 1/4" Shelf Supports
- (448) #8 x 1 1/4" Fh Woodscrews
- (12) #8 x 3/4" Fh Woodscrews

## Cutting Diagram

1/2" x 7 1/2" - 96" POPLAR (5 Sq. Ft.)

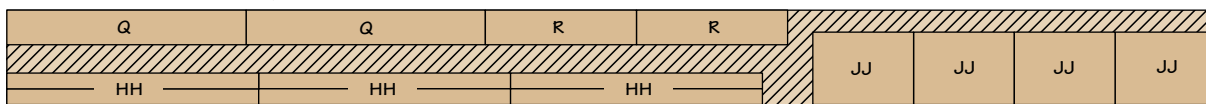

1/2" x 7 1/2" - 96" POPLAR (5 Sq. Ft.)

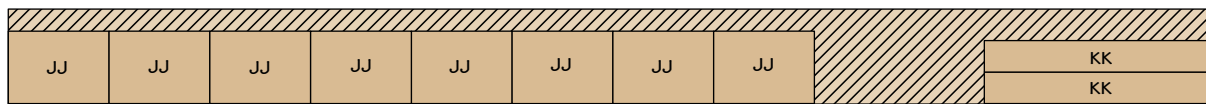

1/2" x 5 1/2" - 96" POPLAR (3.7 Sq. Ft.)

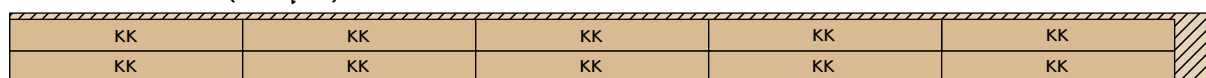

# Cutting Diagram cont.

48" x 96" - 3/4" PLYWOOD

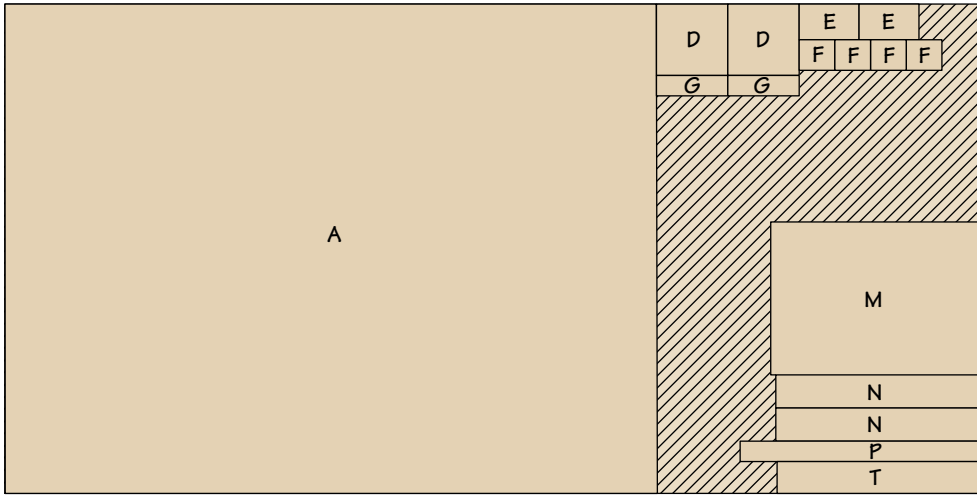

48" x 96" - 3/4" PLYWOOD

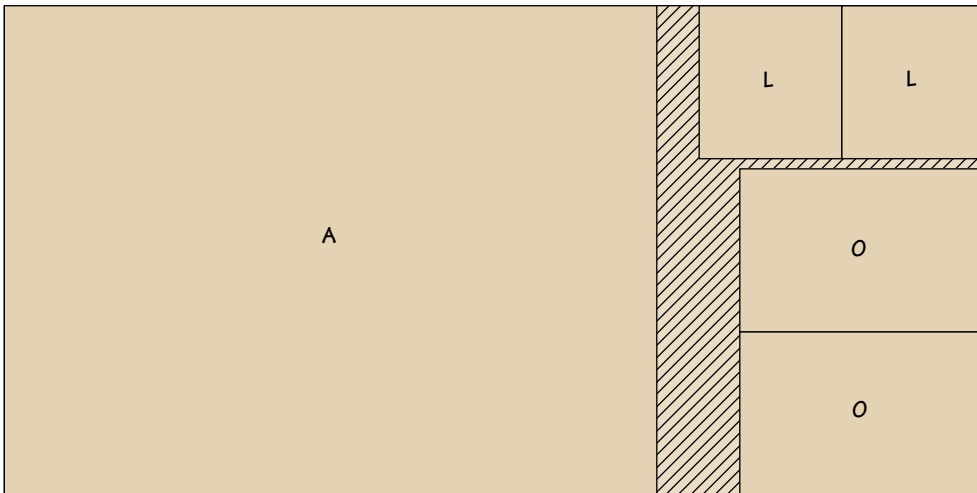

48" x 96" - 3/4" PLYWOOD

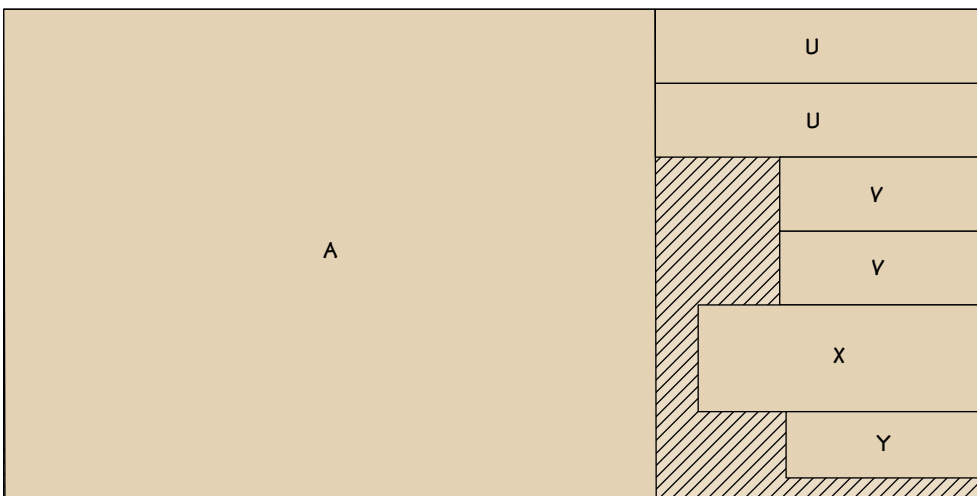

# Cutting Diagram cont.

48" x 96" - 3/4" PLYWOOD

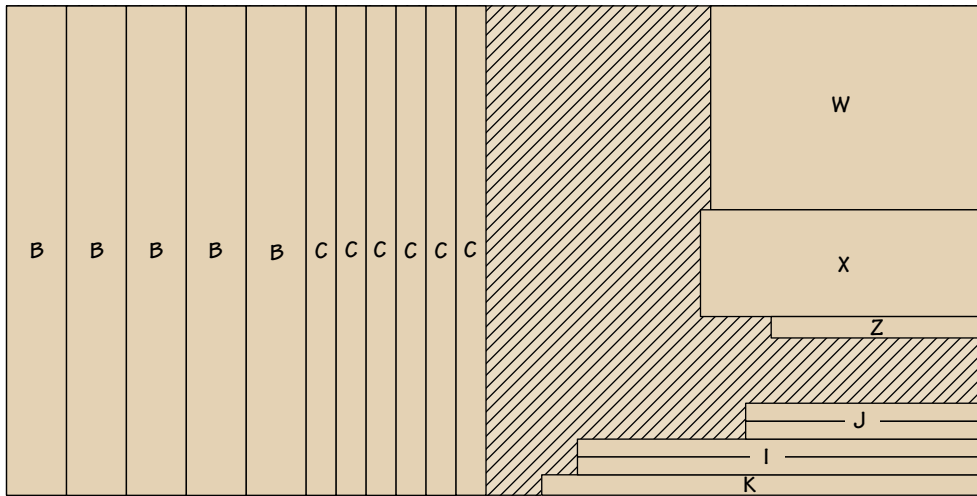

48" x 96" - 3/4" PLYWOOD

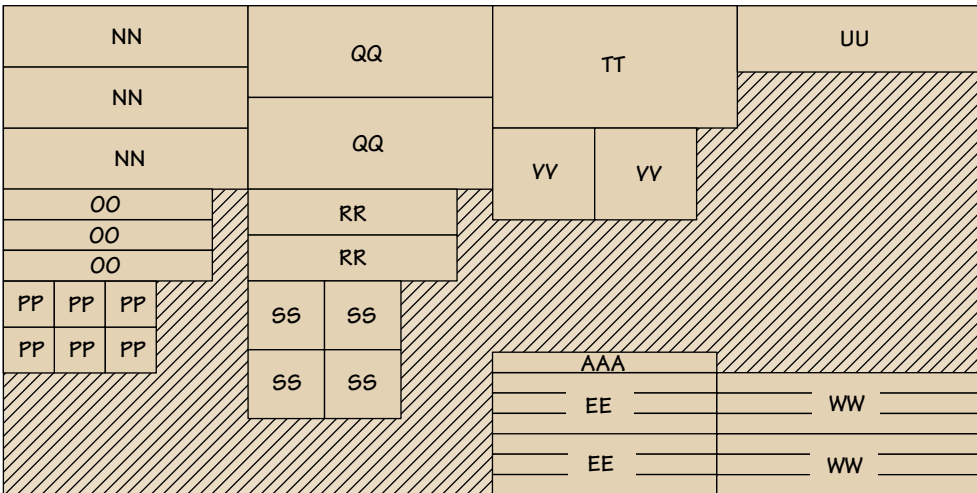

48" x 96" - 3/4" PLYWOOD

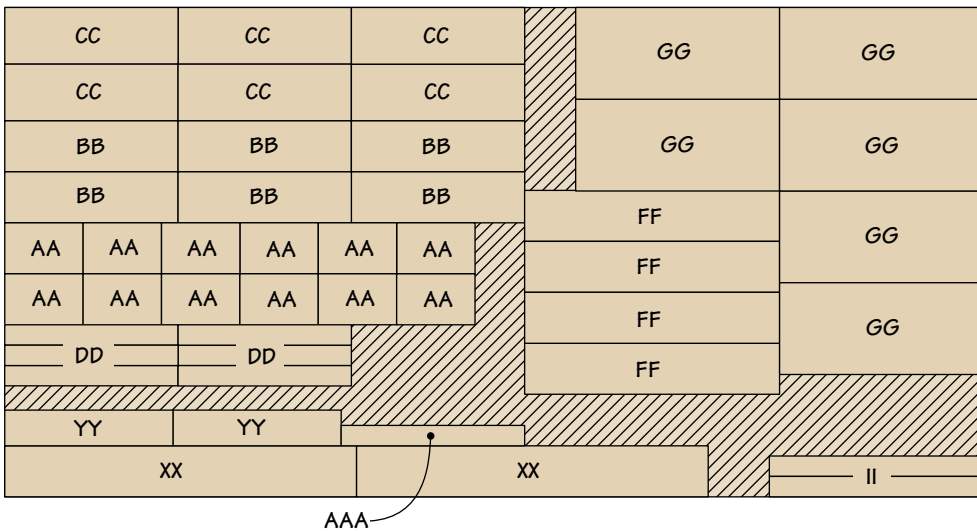

# Cutting Diagram cont.

---

48" x 96" - 3/4" PLYWOOD

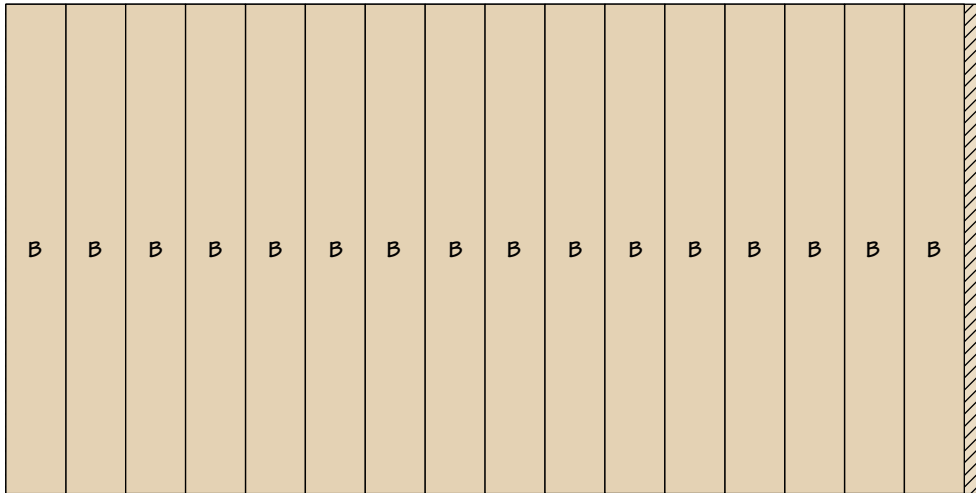

48" x 48" - 1/4" HARDBOARD

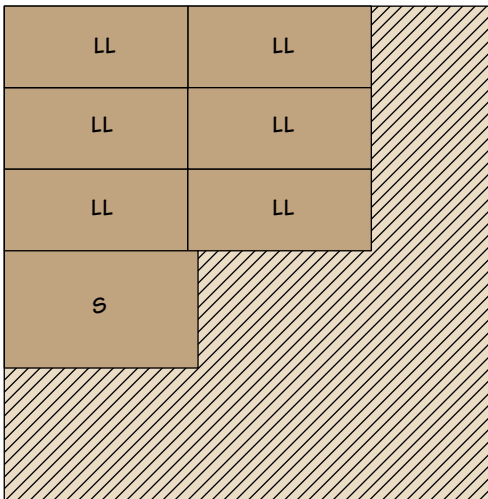

24" x 48" - 1/4" PEGBOARD

